



DF15005S thru DF1510S

Miniature Glass Passivated Single-Phase Surface Mount Bridge Rectifiers
Reverse Voltage 50 to 1000 Volts Forward Current 1.5 Amperes

Features

- ◆ Ideal for printed circuit boards
- ◆ Applicable for automotive insertion
- ◆ High surge current capability
- ◆ Solder Dip 260 °C, 40 seconds

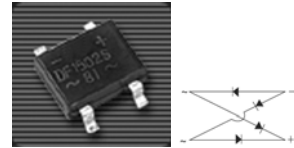

DFS

Mechanical Data

- ◆ Case: DFS
Epoxy meets UL-94V-0 Flammability rating
- ◆ Terminals: Matte tin plated (E3 Suffix) leads, solderable per J-STD-002B and JESD22-B102D
- ◆ Polarity: As marked on body

Typical Applications

General purpose use in ac-to-dc bridge full wave rectification for SMPS, Lighting Ballaster, Adapter, Battery Charger, Home Appliances, Office Equipment, and Telecommunication applications

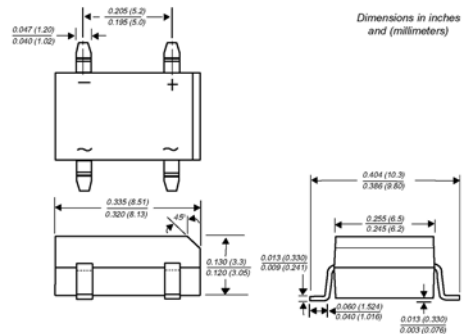

Maximum Ratings and Electrical Characteristics

(T_A=25°C unless otherwise noted)

Parameter	Symbols	DF 15005S	DF 1501S	DF 1502S	DF 1504S	DF 1506S	DF 1508S	DF 1510S	Units
Maximum repetitive peak reverse voltage	V _{RRM}	50	100	200	400	600	800	1000	Volts
Maximum RMS voltage	V _{RMS}	35	70	140	280	420	560	700	Volts
Maximum DC blocking voltage	V _{DC}	50	100	200	400	600	800	1000	Volts
Maximum average forward output rectified current at T _A =40°C ⁽²⁾	I _{F(AV)}	1.5							Amps
Peak forward surge current single half sine-wave superimposed on rated load (JEDEC Method) T _J =150°C	I _{FSM}	50.0							Amps
Rating for fusing (t < 8.3ms)	I ² t	10							A ² sec
Maximum instantaneous forward voltage drop per leg at 0.75A	V _F	1.1							Volts
Maximum DC reverse current at rated DC blocking voltage per leg T _A =25°C T _A =125°C	I _R	5.0 500							µA
Typical junction capacitance per leg ⁽¹⁾	C _J	25							pF
Typical thermal resistance per leg ⁽²⁾	R _{θJA} R _{θJL}	40 15							°C/W
Operating junction and storage temperature range	T _J , T _{STG}	-55 to +150							°C

- Notes:**
1. Measured at 1.0 MHz and applied reverse voltage of 4.0 Volts
 2. Units mounted on P.C.B. with 0.51 x 0.51" (13 x 13mm) copper pads

RATINGS AND CHARACTERISTIC CURVES

($T_A = 25^\circ\text{C}$ unless otherwise noted)

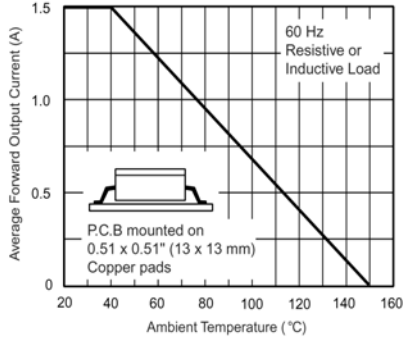

Figure 1. Derating Curve Output Rectified Current

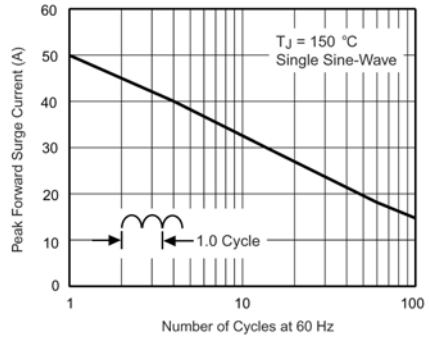

Figure 2. Maximum Non-Repetitive Peak Forward Surge Current Per Leg

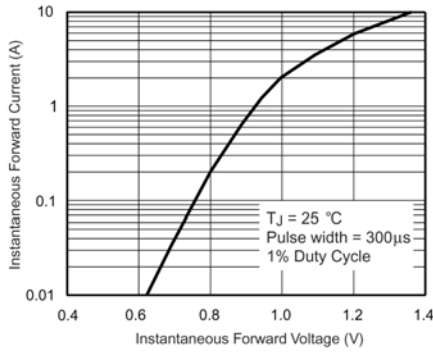

Figure 3. Typical Forward Characteristics Per Leg

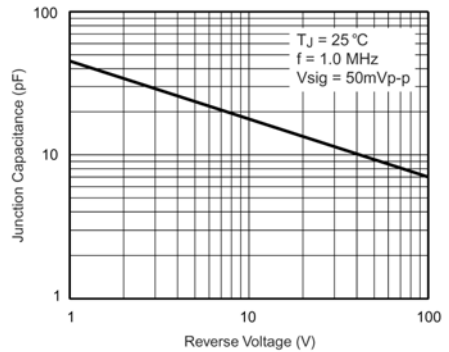

Figure 5. Typical Junction Capacitance Per Leg

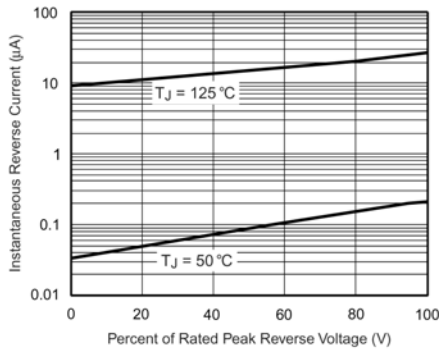

Figure 4. Typical Reverse Leakage Characteristics Per Leg

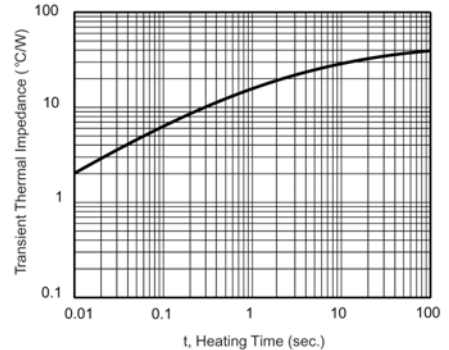

Figure 6. Typical Transient Thermal Impedance