

## Ultra Low Capacitance ESD TVS Array in DFN3810

### Features

- 30 Watts peak pulse power ( $t_p = 8/20\mu s$ )
- DFN3810 package
- Unidirectional configurations
- Protect up to 8-lines
- Low clamping voltage
- Low Leakage current
- Low capacitance ( $C_j=0.2pF$  typ. I/O to I/O)
- IEC 61000-4-2  $\pm 8kV$  contact  $\pm 15kV$  air
- IEC 61000-4-4 (EFT) 40A (5/50ns)
- IEC 61000-4-5 (Lightning) 3A (8/20 $\mu s$ )

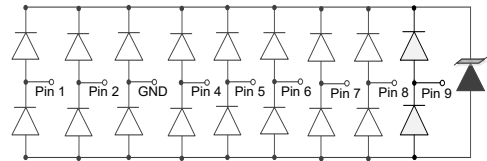
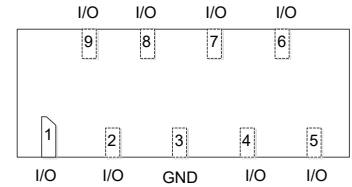
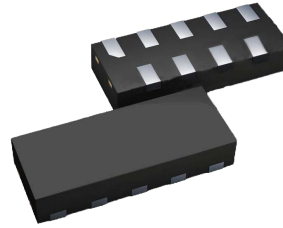

### Mechanical Data

- **Case:** DFN3810 (plastic package).  
Lead free; RoHS compliant
- **Molding Compound Flammability Rating:**  
UL 94 V-0
- **Terminals:** High temperature soldering guaranteed:  
260 °C/10 sec. at terminals

### Applications

- USB 3.0/3.1, Type C
- HDMI 1.4/2.0, Display Port 1.3
- Unified Display interface
- Digital visual interface

### Absolute Maximum Ratings

Ratings at 25 °C, ambient temperature unless otherwise specified

Parameter	Symbol	Value	Unit
Peak Pulse Power ( $T_P=8/20\mu s$ )	$P_{PP}$	30	W
ESD contact/air discharge (IEC-61000-4-2)	$V_{ESD}$	8/15	kV
Peak Pulse Current ( $t_p = 8/20\mu s$ )	$I_{PP}$	3	A
Junction Temperature	$T_J$	-55 to +125	°C
Storage temperature	$T_{STG}$	-55 to +150	°C

### Electrical Characteristics

( $T_A = 25\text{ °C}$  unless otherwise specified)

Parameter	Symbol	Condition	Min	Typ	Max	Unit
Reverse stand-off Voltage	$V_{RWM}$				5	V
Reverse Breakdown Voltage	$V_{BR}$	$I_T=1mA$	5.6			V
Reverse Leakage Current	$I_R$	$V_R=5V$		0.1	0.5	$\mu A$
Clamping Voltage(SURGE)	$V_C$	$I_{PP}=3A, T_P=8/20\mu s$		10		V
Junction Capacitance	$C_J$	$V_R=0V, f=1MHz, I/O$ to I/O		0.2		pF
	$C_J$	$V_R=0V, f=1MHz, I/O$ to GND		0.4		pF

## Typical Characteristics (T<sub>amb</sub> = 25 °C unless otherwise specified)

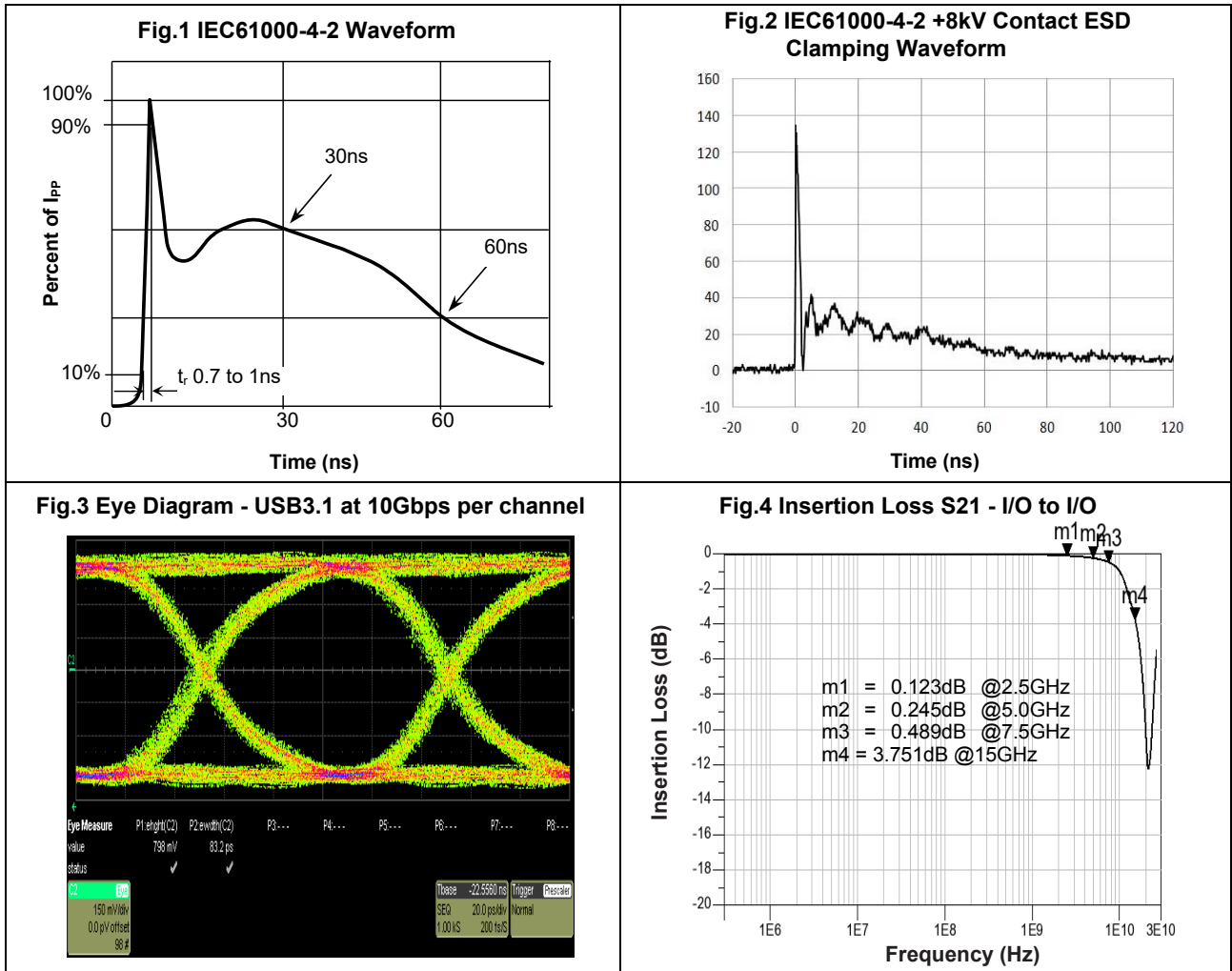

## HDMI Space Saving Solution

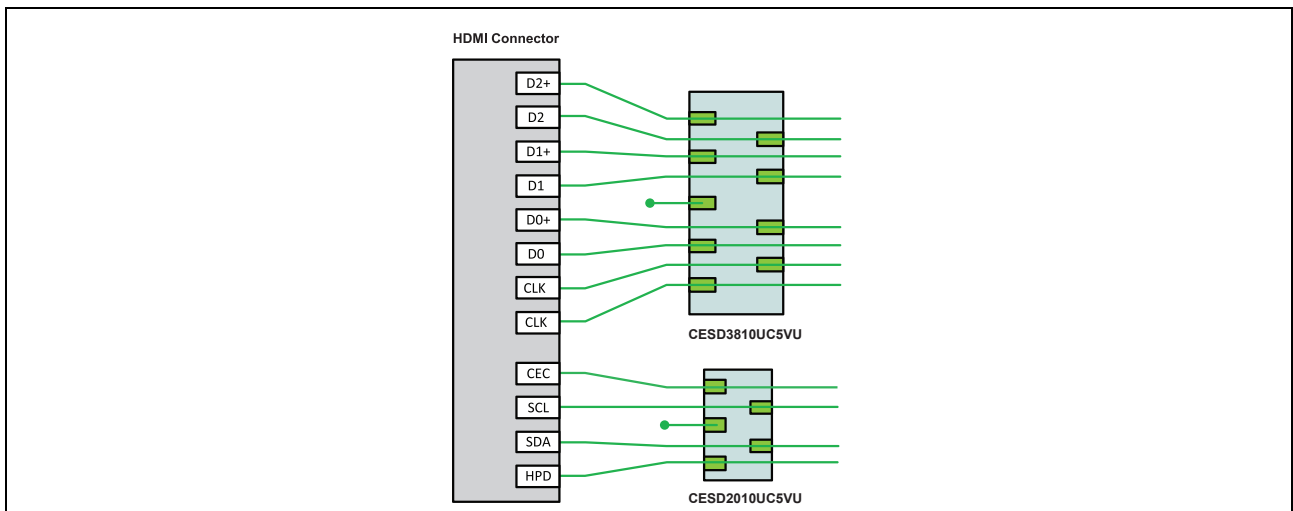

## Package Dimensions

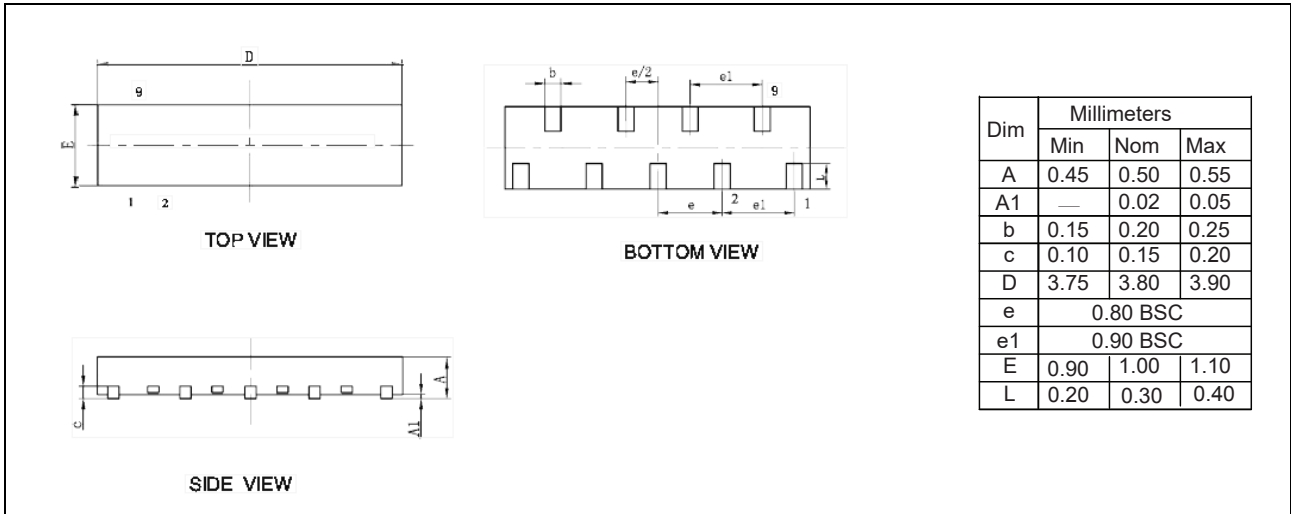

## PAD Dimensions

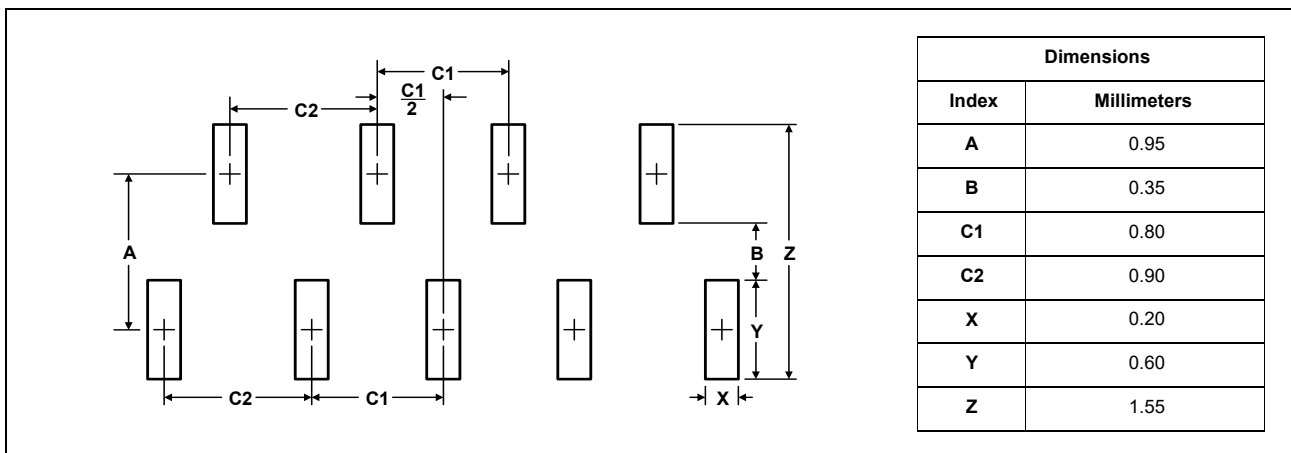

## Marking



## Ordering information

Order code	Package	Packaging option	Base quantity	Packaging specification
TESD3810UC5VU	DFN3810	Tape and reel	3000pcs / reel	EIA STD RS-481