

Ultra` Low Capacitance ESD Protection Diode in \$* \$'

Features

- ESD protection for high speed data lines to IEC61000-4-2
- ESD contact discharge typical 8KV, max 30KV
- ESD air discharge typical 15KV, max 30KV
- Surface mount
- Extremely low capacitance
- Very low leakage current
- Fast response time
- Bi-directional ESD protection
- Lead free solder termination
- The best ESD protection for high frequency, low voltage applications

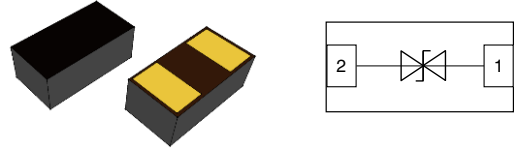

Mechanical Data

- **Case:** ϵ ϵ (plastic package).
Lead free; RoHS compliant; Halogen free
- **Molding Compound Flammability Rating:**
UL 94 V-0
- **Terminals:** High temperature soldering guaranteed:
260 °C/10 sec. at terminals

Applications

- USB3.0, Firewire, DVI, HDMI, S-ATA
- Thunderbolt, Display Port
- Mobile HDMI Link, MDDI, MIPI, SWP / NFC



Caution:
This component is designed for signal line protection only,
Not intended to be used under bias, not for application with
a power line.

Absolute Maximum Ratings

Ratings at 25 °C, ambient temperature unless otherwise specified

Parameter	Symbol	Value	Unit
Maximum Contact discharge voltage Per IEC61000-4-2	---	30KV	V
Maximum Air discharge voltage Per IEC61000-4-2	---	30KV	V
Maximum Operating temperature	T _{OPER}	-40 to +125	°C
Maximum Storage temperature	T _{STG}	-55 to +125	°C
Maximum lead temperature for soldering during 10s	T _L	260	°C

Electrical Characteristics

(T_A = 25 °C unless otherwise specified)

Parameter	Symbol	Test Conditions	Min	Typ	Max	Units
Rated Voltage	V _R	---			6	V
Trigger voltage	V _T	IEC61000-4-2 8KV contact discharge	---	350	---	V
Clamping voltage	V _C	IEC61000-4-2 8KV contact discharge	---	35	---	V
Leakage current	I _L	DC 12V shall be applied on component	---		0.10	uA
Capacitance	C _P	V _R = 0V, f = 1MHz	---	0.05		pF

Note: 1 Trigger and clamping voltage are measured per IEC 61000-4-2, 8KV contact discharge method.

2 After reliability tests such as high temp storage, temp cycles, continuous ESD strike etc, the maximum leakage current is less than 10uA.

ESD Clamping Test

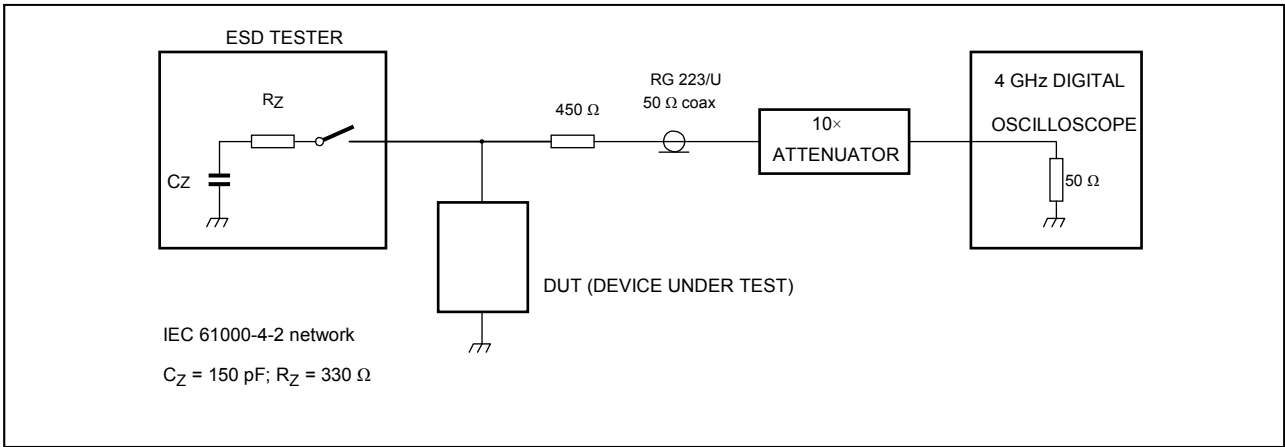

Typical Characteristics

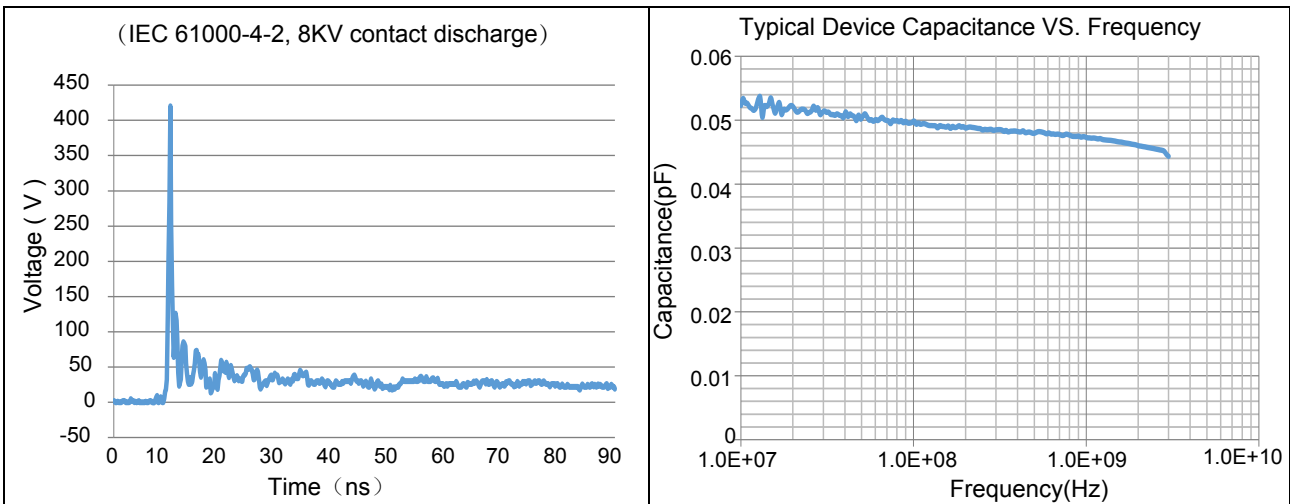

ESD Protection for Signal Line

The CESD is designed for the protection of one bidirectional data line from ESD damage.

- Place the CESD as close to the input terminal or connector as possible.
- Minimize the path length between the CESD and the protected signal line.
- Use ground planes whenever possible.

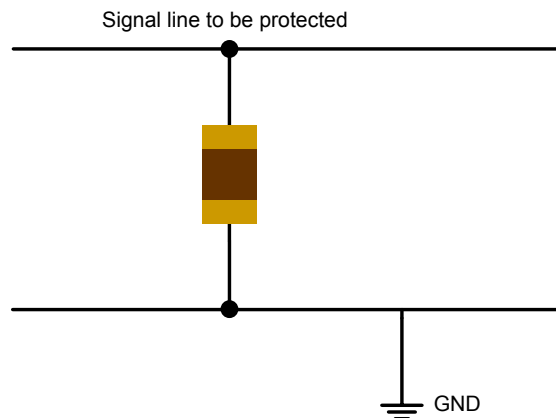

Product Dimension

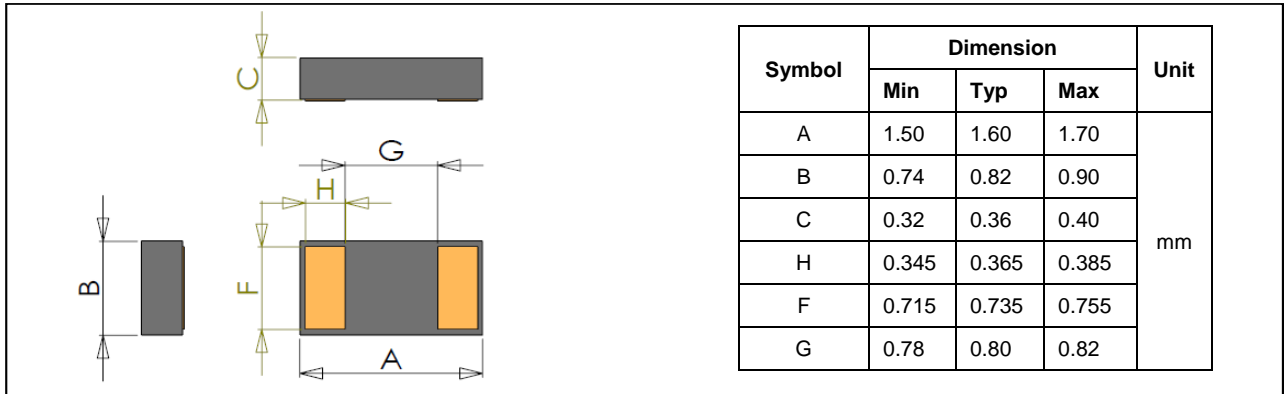

PAD Dimension

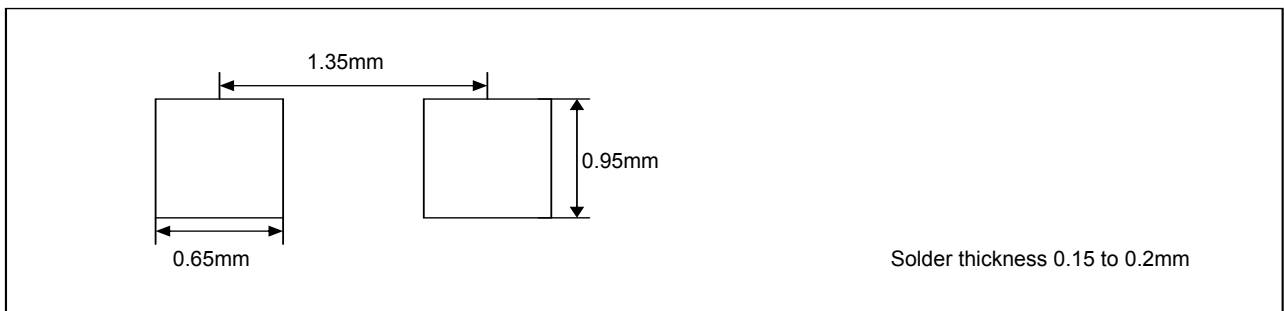

Solder Reflow Recommendations

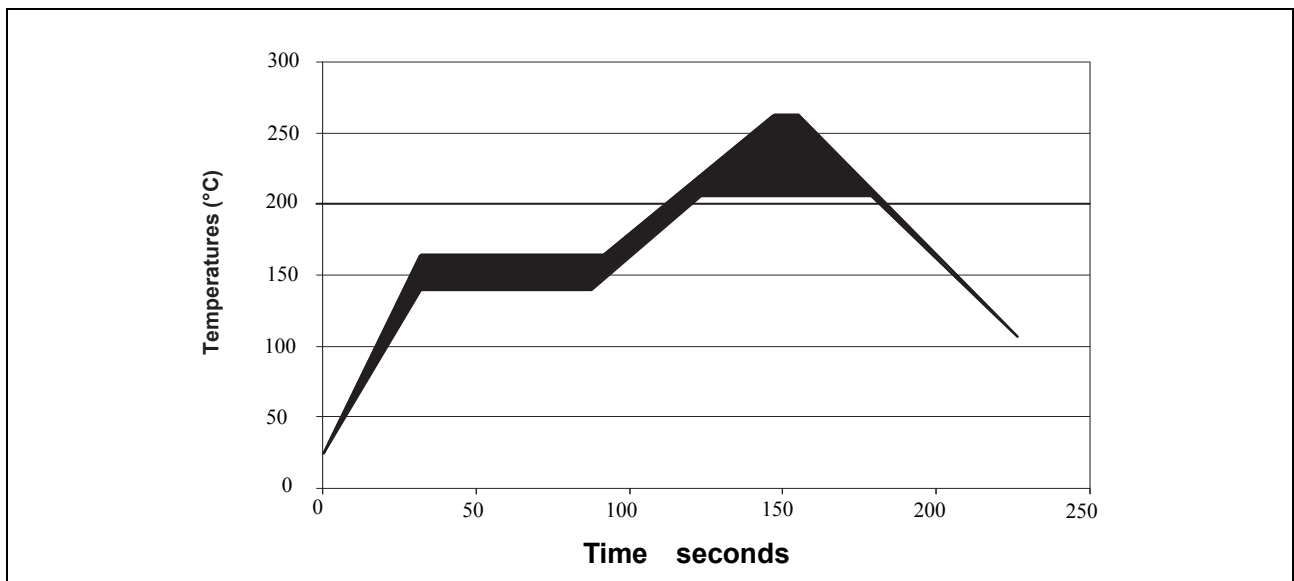

Package Information

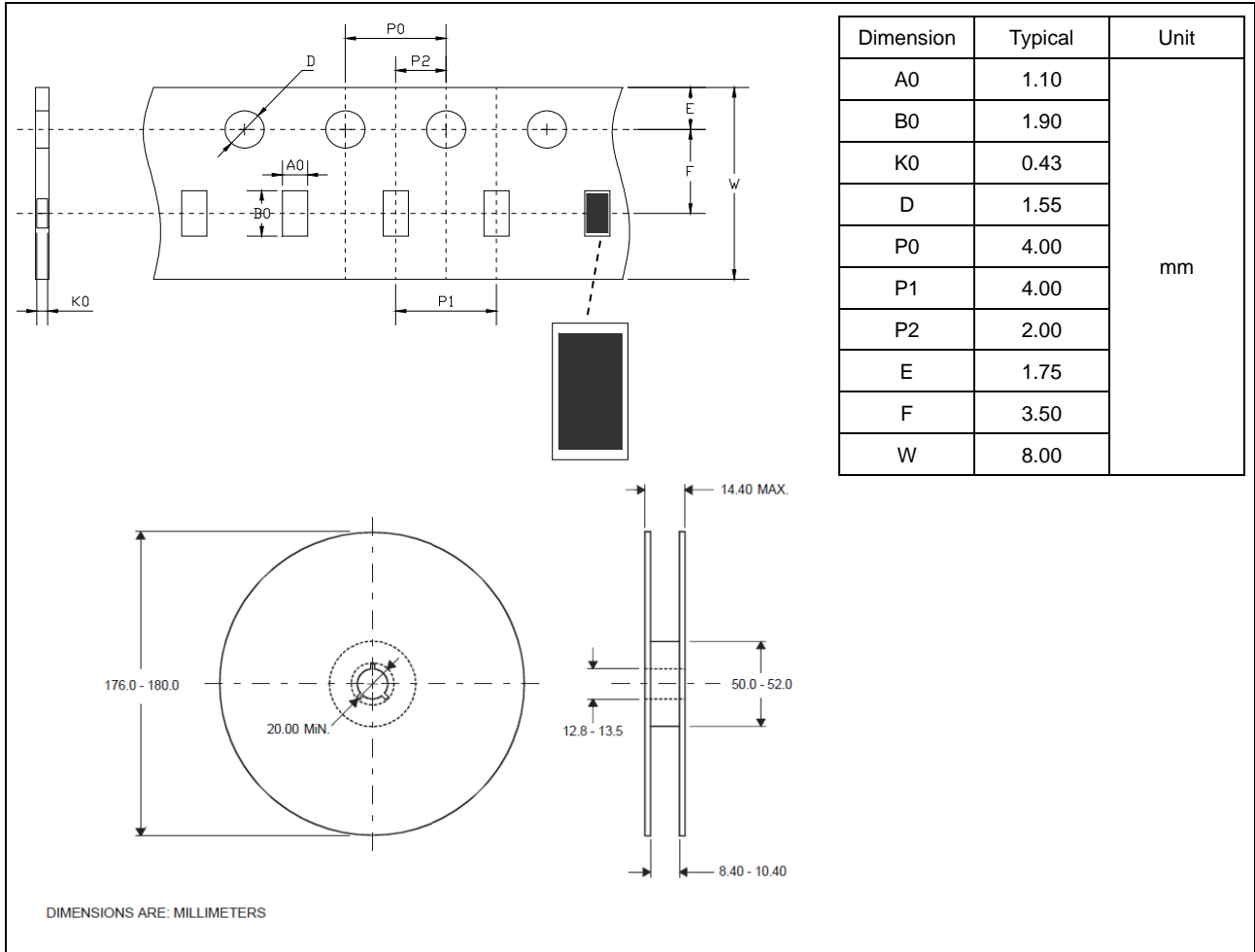

Ordering information

Order code	Package	Packaging option	Base quantity	Packaging specification
TESDP0603UC6VB	0603	Tape and reel	5000pcs / reel	EIA STD RS-481